

CSX Transportation, Inc. Tank Car Release of UN1987
Denatured Ethanol
Fredericksburg, Virginia
November 2, 2016



Incident Report

NTSB/HZM-20/01
PB2022-100361



**National
Transportation
Safety Board**

NTSB/HZM-20/01
PB2022-100361
Notation 64530
Adopted February 14, 2020

Hazardous Materials Incident Report

CSX Transportation, Inc. Tank Car Release of UN1987
Denatured Ethanol
Fredericksburg, Virginia
November 2, 2016



**National
Transportation
Safety Board**

490 L'Enfant Plaza, S.W.
Washington, D.C. 20594

National Transportation Safety Board. 2020. *CSX Transportation, Inc. Tank Car Release of UN 1987 Denatured Ethanol, Fredericksburg, Virginia, November 2, 2016. Hazardous Materials Incident Report NTSB/HZM-20/01.* Washington, DC: NTSB.

Abstract: On November 2, 2016, at 3:11 p.m. local time, CSX Transportation, Inc. (CSX) reported a 68-gallon release of UN1987 denatured ethanol, a flammable Class 3 hazardous material, from cracks in the bottom of the shell of Archer Daniels Midland Company tank car ADMX 29899. The incident occurred in the CSX rail yard located in Fredericksburg, Virginia. ADMX 29899 was the sixth tank car in train D79402, consisting of a buffer car and seven tank cars fully loaded with denatured ethanol. Due to the release and emergency rail traffic, other traffic on adjacent main tracks was slowed, causing passenger train delays during peak traffic hours. The incident location was bordered by commercial businesses and residential neighborhoods. Weather at the time of the incident was sunny, and the temperature was 79°F. At 3:12 p.m., the fire department discovered ethanol leaking from the bottom of the tank car. They noted that leaking ethanol was spilling onto ballast on the right of way, but the warm weather accelerated its evaporation. By 3:45 p.m., a railroad emergency response contractor collected the leaking ethanol in an open container and moved the tank car to an adjacent track where the product could be transferred to another tank car. Crews completed the transfer by 3:15 a.m. on November 3. As a result of this investigation, the National Transportation Safety Board made four new recommendations to the Federal Railroad Administration and the Pipeline and Hazardous Materials Safety Administration.

The National Transportation Safety Board (NTSB) is an independent federal agency dedicated to promoting aviation, railroad, highway, marine, and pipeline safety. Established in 1967, the agency is mandated by Congress through the Independent Safety Board Act of 1974, to investigate transportation accidents, determine the probable causes of the accidents, issue safety recommendations, study transportation safety issues, and evaluate the safety effectiveness of government agencies involved in transportation. The NTSB makes public its actions and decisions through accident reports, safety studies, special investigation reports, safety recommendations, and statistical reviews.

The NTSB does not assign fault or blame for an accident or incident; rather, as specified by NTSB regulation, “accident/incident investigations are fact-finding proceedings with no formal issues and no adverse parties ... and are not conducted for the purpose of determining the rights or liabilities of any person” (Title 49 *Code of Federal Regulations* section 831.4). Assignment of fault or legal liability is not relevant to the NTSB’s statutory mission to improve transportation safety by investigating accidents and incidents and issuing safety recommendations. In addition, statutory language prohibits the admission into evidence or use of any part of an NTSB report related to an accident in a civil action for damages resulting from a matter mentioned in the report (Title 49 *United States Code* section 1154(b)).

For more detailed background information on this report, visit the [NTSB investigations website](#) and search for NTSB accident ID DCA17SH001. Recent publications are available in their entirety on [the NTSB website](#). Other information about available publications also may be obtained from the website or by contacting—

National Transportation Safety Board
Records Management Division, CIO-40
490 L’Enfant Plaza, SW
Washington, DC 20594
(800) 877-6799 or (202) 314-6551

Copies of NTSB publications may be downloaded at no cost from the National Technical Information Service, at the [National Technical Reports Library search page](#), using product number PB2022-100361. For additional assistance, contact—

National Technical Information Service
5301 Shawnee Rd. Alexandria, VA 22312
(800) 553-6847 or (703) 605-6000
[NTIS website](#)

Contents

Figures	iii
Tables	iv
Abbreviations and Acronyms	v
Executive Summary	vi
Probable Cause.....	vi
Safety Issues.....	vi
Conclusions.....	vii
Recommendations.....	vii
1 Factual Information	1
1.1 The Shipment	3
1.2 Tank Car ADMX 29899.....	4
1.2.1 Construction Details.....	4
1.2.2 ACF-200 Stub Sill Underframe	4
1.2.3 Service and Maintenance History	5
1.3 Stub Sill Inspection and Maintenance Guidance.....	5
1.3.1 Federal Railroad Administration Safety Advisory	5
1.3.2 Association of American Railroads Maintenance Advisory.....	6
1.3.3 ACF Maintenance Bulletin TC-200, Revision B.....	7
1.4 Postincident Tank Car Examination.....	8
1.4.1 Shell Cracks	8
1.4.2 Shell Buckling.....	9
1.4.3 Materials Testing	10
1.5 Coupling Impact Loads	10
1.5.1 Finite Element Modeling and Analysis of Draft Gear Forces	10
1.5.2 Coupling Speed Regulations and Recommended Practices.....	12
2 Analysis	15
2.1 Excessive Coupling Impact Loads	15
2.2 Structural Integrity of Stub Sill Underframes	15
2.3 Detecting Energetic Coupling Events	17
3 Conclusions	19
3.1 Findings.....	19
3.2 Probable Cause.....	19
4 Recommendations	20
Appendix	21

References22

Figures

Figure 1. Aerial view of incident location.	1
Figure 2. Tank car ADMX 29899 at the incident location.	2
Figure 3. Ethanol leaking from the cracked tank shell.	3
Figure 4. Generalized configuration of an ACF-200 stub sill underframe.	5
Figure 5. Diagram of a tank car stub sill underframe highlighting damage-prone critical locations where weld cracks are likely to occur.	7
Figure 6. B-end tank car section, including the inboard end of the stub sill cradle pad and two shell cracks.	8
Figure 7. Plot of laser scan data showing tank shell buckling depth found at the inboard end of the cradle pad.	9
Figure 8. Visual rendering of laser scan data showing tank shell buckling at the inboard end of the cradle pad.	10
Figure 9. Finite element model result showing vertical displacement in inches following a quasi-static draft gear force of 3,715 kips.	11
Figure 10. Finite element modeling output showing vertical displacement contours of the rotated tank bottom near the buckled region.	16

Tables

Table. Canadian Transport of Dangerous Goods coupling speed regulatory thresholds for structural integrity inspection. 13

Abbreviations and Acronyms

AAR	Association of American Railroads
ACF	ACF Industries, LLC
ADM	Archer Daniels Midland Company
ARI	American Railcar Industries, Inc.
ARL	American Railcar Leasing
CFR	<i>Code of Federal Regulations</i>
CL	critical location
CSX	CSX Transportation, Inc.
DOT	US Department of Transportation
FR	<i>Federal Register</i>
FRA	Federal Railroad Administration
GRL	gross rail load
Kip	kilopounds
MA	maintenance advisory
MSRP	<i>Manual of Standards and Recommended Practices</i>
NTSB	National Transportation Safety Board
PHMSA	Pipeline and Hazardous Materials Safety Administration
psi	pounds per square inch
RSAC	Railroad Safety Advisory Committee
TC	Transport Canada
TDG	Canadian Transport of Dangerous Goods
TSB	Transportation Safety Board of Canada

Executive Summary

On November 2, 2016, at 3:11 p.m. local time, CSX Transportation, Inc. reported a 68-gallon release of UN1987 denatured ethanol, a flammable Class 3 hazardous material, from cracks in the bottom of the shell of Archer Daniels Midland Company tank car ADMX 29899. The incident occurred in the CSX Transportation, Inc. rail yard located in Fredericksburg, Virginia. ADMX 29899 was the sixth tank car in train D79402, consisting of a buffer car loaded with steel and seven tank cars fully loaded with denatured ethanol. Due to the release and the resulting emergency rail traffic, other rail traffic on adjacent main tracks was significantly slowed, causing passenger train delays during peak traffic hours. The incident location was bordered by commercial businesses and residential neighborhoods. Weather at the time of the incident was sunny, and the temperature was 79°F.¹

At 3:12 p.m., the Fredericksburg Fire Department dispatched to the incident scene and discovered ethanol leaking from the bottom of the tank car. The fire department noted that leaking ethanol was spilling onto ballast on the right of way, but the unseasonably warm weather accelerated its evaporation. By 3:45 p.m., a railroad emergency response contractor arrived on site and collected the leaking ethanol in an open container and moved the tank car to an adjacent track where the product could be transferred to another tank car. Crews completed the transfer by 3:15 a.m. on November 3.

Probable Cause

The National Transportation Safety Board determines that the probable cause of the November 2, 2016, release of denatured ethanol from Archer Daniels Midland Company tank car ADMX 29899 was undetected cracks that resulted from overspeed high-energy coupling events, which caused tank shell deformation that led to the initiation of two fatigue cracks at the terminations of the cradle pad fillet welds.

Safety Issues

This report focuses on the following safety issues:

- [Excessive coupling impact loads and the need for maximum coupling speed and impact force thresholds.](#)
- [Structural integrity of stub sill underframes and need for qualified inspection and repair following high-energy coupler impact events.](#)
- [Methods to detect and report excessive coupling speed impact events.](#)

¹ For more information, see the factual information and analysis sections of this report. Additional information about this accident investigation can be found in the public docket for this accident (NTSB case number DCA17SH001) by accessing the [Accident Dockets link](#) for the Docket Management System at www.nts.gov. For more information on our safety recommendations, see the [Safety Recommendations Database](#) at www.nts.gov.

Conclusions

- [The tank shell buckle was likely the result of coupling at a speed above the Association of American Railroads-recommended 4 mph.](#)
- [The risk of a hazardous materials release following high-force coupling events could be mitigated if federal regulations provided limits in the combination of coupling speed and impacting mass to tank car coupler and underframe components.](#)
- [The decision to not install the P470 head brace enhancement on tank car ADMX 29899 did not affect the formation of a shell buckle in the region where the tank shell cracks occurred.](#)
- [The shell buckle inboard of the cradle pad led to premature fatigue cracking in the tank shell.](#)
- [Structural integrity inspections must be performed by qualified technicians at certified tank car facilities using specialized nondestructive examination techniques with a sufficient probability of detection to ensure that critical flaws are identified in tank materials.](#)
- [Without a means to detect and report excessive coupling speed events, damaged tank cars such as ADMX 29899 may continue in service and pose an unnecessary risk of hazardous materials releases.](#)

Recommendations

To the Federal Railroad Administration and the Pipeline and Hazardous Materials Safety Administration:

- [Work together to develop maximum coupling speed thresholds and impact mass limits for hazardous materials railcars. \(R-20-1\)](#)
- [Require that tank cars involved in high-energy coupling-force events undergo a structural integrity inspection by a qualified technician before returning to service. \(R-20-2\)](#)
- [Develop methods to identify tank cars that have sustained overspeed and high-energy coupling force events. \(R-20-3\)](#)
- [After the successful development of methods to identify tank cars that have sustained overspeed and high-energy coupling force events, require that rail carriers have monitoring processes in place to promptly remove damaged tank cars from hazardous materials service. \(R-20-4\)](#)

1 Factual Information

On November 2, 2016, at 3:11 p.m. local time, CSX Transportation, Inc. (CSX) reported a 68-gallon release of UN1987 denatured ethanol, a flammable liquid Class 3 hazardous material, from cracks in the bottom of the shell of Archer Daniels Midland Company (ADM) tank car ADMX 29899. The incident occurred in the CSX rail yard located in Fredericksburg, Virginia. (See figure 1.)

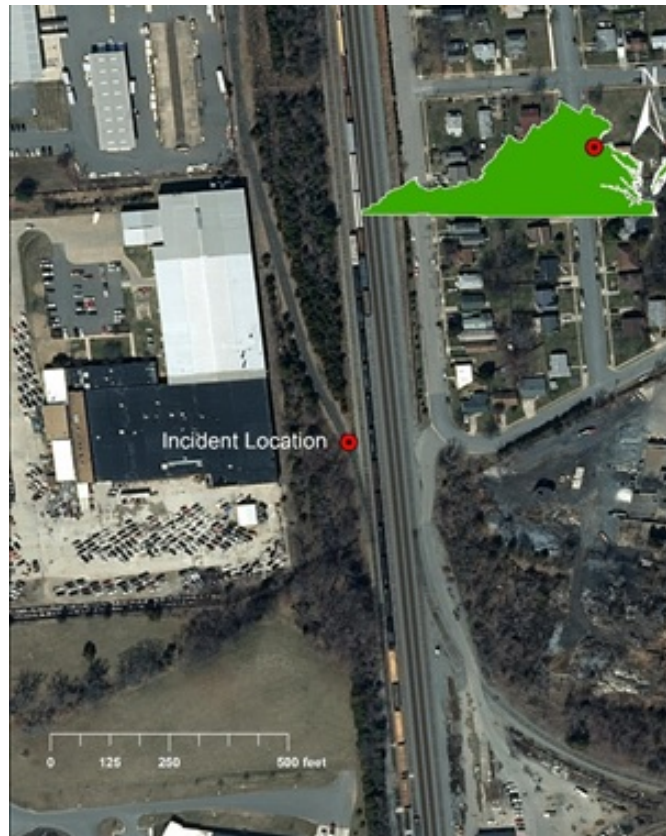

Figure 1. Aerial view of incident location.

Train D79402 consisted of a buffer car loaded with steel and seven tank cars fully loaded with denatured ethanol. ADMX 29899 was the sixth tank car in the train. (See figure 2.) Other rail traffic on adjacent main tracks was significantly slowed, causing passenger train delays during peak traffic hours. The incident location was bordered by commercial businesses and residential neighborhoods. Weather at the time of the incident was sunny, and the temperature was 79°F.



Figure 2. Tank car ADMX 29899 at the incident location.

At 3:12 p.m., the Fredericksburg Fire Department dispatched to the incident scene and discovered ethanol leaking at the B-end inboard side of the stub sill cradle pad near the termination of the left side longitudinal cradle pad-to-tank fillet weld.² (See figure 3.) The fire department noted that leaking ethanol was spilling onto ballast on the right of way, but the unseasonably warm weather accelerated its evaporation. By 3:45 p.m., a railroad emergency response contractor arrived on site, collected the leaking ethanol in an open container, and moved the tank car to an adjacent track where the product could be transferred to another tank car. Crews completed the transfer by 3:15 a.m. on November 3.

² (a) A *cradle pad* is a reinforcing plate welded directly to the tank to which the stub sill is attached. The pad protects the tank from damage caused by fatigue, overstress, denting, puncturing, or tearing. In tank cars with stub sills, the tank is used as the primary structural component to carry longitudinal train loads. Couplers are attached to the outer end of the stub sills at each end of the tank. (b) All orientations referenced in this report are as seen when facing the B-end of the tank car.



Figure 3. Ethanol leaking from the cracked tank shell. (Photograph courtesy of CSX.)

1.1 The Shipment

According to the safety data sheet for denatured ethanol, the product was a mixture of 95 to 98 percent ethanol and 2 to 5 percent natural gasoline. For transportation as a hazardous material, the shipper classified the denatured ethanol as a Class 3 flammable liquid in Packing Group II, with a US Department of Transportation (DOT) shipping name of “Alcohols, n.o.s.” (not otherwise specified). The product was a clear, colorless liquid that had a flash point of -5°F, a Reid vapor pressure of 3.5 pounds per square inch (psi), and a specific gravity of 0.79 (the specific gravity of water is 1).³ The denatured ethanol from the incident tank car was intended to be used in blending with motor fuel.

On October 21, 2016, the denatured ethanol shipment originated from ADM’s Corn Processing Division in Cedar Rapids, Iowa. Records show that before and after loading, the ADM loading rack operator inspected tank car ADMX 29899 and noted no evidence of dents, punctures, or signs of leakage. ADM loaded the tank car with 188,812 pounds, or 28,695 gallons, of denatured

³ *Reid vapor pressure* is most commonly used as a measure of volatility for hydrocarbon fuels and is defined as the vapor pressure of a liquid at 100°F as determined by method ASTM D323.

ethanol. The lading did not exceed the maximum load limit by weight and did not exceed the DOT filling limit by volume.⁴

The destination of the shipment was ExxonMobil in care of Transflo, Fredericksburg, Virginia. According to the car location message report, ADM released ADMX 29899 to the Cedar Rapids & Iowa City Railway Company on October 21, 2016. The Indiana Harbor Belt Railroad received the tank car in Chicago, Illinois, on October 24, 2016. CSX received the tank car in Chicago, Illinois, on October 25, 2016, and retained custody of the car until it arrived at the incident location.

1.2 Tank Car ADMX 29899

1.2.1 Construction Details

Tank car ADMX 29899 was a nonjacketed specification DOT-111A100W1 general service tank car that ACF Industries, LLC (ACF) manufactured in 1989 for ADM.⁵ The tank car had a capacity of 30,094 gallons, a load limit of 196,600 pounds, and a gross rail load (GRL) of 263,000 pounds. The tank was constructed of 7/16-inch Association of American Railroads (AAR) TC-128 grade B non-normalized steel shell, and 15/32-inch elliptical ASTM A-516 grade 70 heads.⁶ The tank car was equipped with two pressure relief devices with a start-to-discharge pressure of 75 psi. The tank car was constructed for use in ethanol service and for products authorized in Title 49 *Code of Federal Regulations (CFR)* Part 173 for which there were no special commodity requirements and nonregulated commodities that were compatible with this class of tank car.

1.2.2 ACF-200 Stub Sill Underframe

ACF Industries, Inc. built the tank car in July 1987.⁷ The tank car was equipped with an ACF-200 stub sill underframe design. ACF's successor corporation, American Railcar Industries, Inc. (ARI), under its subsidiary American Railcar Leasing (ARL), issued additional instructions that detailed the inspection and defect repairs needed on nonpressure tank cars equipped with ACF-200 underframes (ARL 2006).⁸ The design uses cradle pads welded to the tank to transfer running loads from the stub sills through the tank. (See figure 4.) ACF used its ACF-200 stub sill

⁴ The maximum load limit by weight stenciled on the tank car was 196,600 pounds. Based on the coefficient of cubical expansion for ethanol, the maximum allowable filling limit at the loading temperature of 84°F was 29,240 gallons as mandated by Title 49 *Code of Federal Regulations (CFR)* 173.24b.

⁵ American Car and Foundry (ACF), today known as ACF Industries, LLC, is a manufacturer of railroad rolling stock based in St. Charles, Missouri.

⁶ ASTM International, formerly known as American Society for Testing and Materials, is an international standards organization that develops and publishes voluntary consensus technical standards for a wide range of materials, products, systems, and services.

⁷ In 1994, American Railcar Industries, Inc. was formed from the acquisition of railcar component manufacturing and railcar maintenance assets from ACF Industries, Inc.

⁸ At the time the instructions were issued, ARI was the parent company and ARL was the subsidiary. ARI manufactured the car but ARL issued the guidance. However, on June 1, 2017, Sumitomo Mitsui Banking Corporation completed the acquisition of ARL.

underframe design in tank cars built between 1969 and 1996, and about 9,000 of those nonpressure tank cars are currently in service.⁹

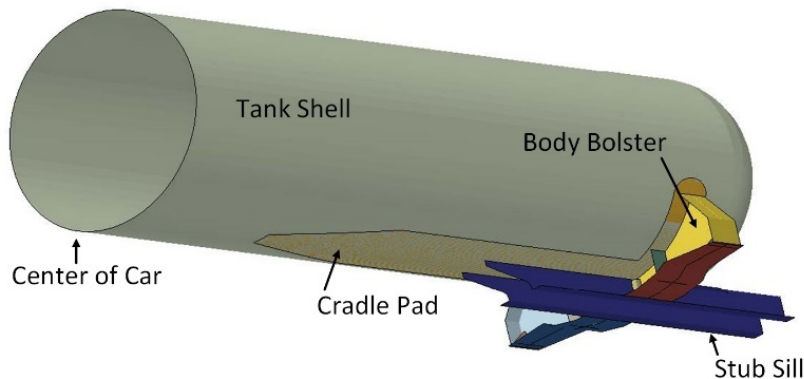

Figure 4. Generalized configuration of an ACF-200 stub sill underframe.

1.2.3 Service and Maintenance History

The ADM billing and repair records for ADMX 29899 from 1991 through the date of the accident did not show that the tank car had been shopped or repaired as a result of any accident-related damage.¹⁰ ADM records documented that on May 14, 2012, its Cedar Rapids, Iowa, railcar repair facility conducted a 10-year HM-201 requalification inspection, stub sill inspection, and shell thickness test on the tank car (*Federal Register*, 1995, 49048). At the time of this inspection the tank car had logged 276,000 miles. The HM-201 inspection included visual inspections for abrasions, corrosion, cracks, dents, distortions, and defects in welds. Both interior and exterior inspections found no exceptions. The stub sill inspection found no transverse or longitudinal weld cracks. However, ADM found and repaired four 3-inch cracks in the A-end and B-end bolster pads (two each). The shell thickness measurements were within specification. The next HM-201 tank requalification inspection and thickness test would have been scheduled to occur in 2022.

1.3 Stub Sill Inspection and Maintenance Guidance

1.3.1 Federal Railroad Administration Safety Advisory

In 2006, the Federal Railroad Administration (FRA) issued Safety Advisory 2006-04, Notice No. 2, in which it noted that since 1990, the FRA and Transport Canada (TC) had documented defects on tank car underframes that in some instances led to hazardous materials incidents (FRA 2006). The notice also stated that AAR stub sill inspection data related to the ACF-200 stub sill underframes showed significant percentages of longitudinal weld cracks in the pad-to-sill area and parent metal cracks in the cradle pad. The FRA stated that these cracks

⁹ Source: Universal Machine Language Equipment Register.

¹⁰ The term *shopped* refers to taking the tank car to a facility certified by the AAR for building and repairing railroad tank cars.

presented a possible source of the loss of tank integrity, which could lead to the release of hazardous materials. Therefore, the FRA recommended that owners of tank cars equipped with the ACF-200 stub sill inspect and enhance these underframes, in accordance with ACF maintenance bulletin TC-200, including the installation of a head brace (ARL 2006).¹¹ The FRA recommended that ACF-200 tank car owners should modify these tank cars at the earliest of any of the following events:

- A tank car is due for requalification under 49 *CFR* 180.509;
- A tank car is recalled under an AAR Maintenance Advisory (MA) requiring modification in the draft sill area;
- A tank car has been in service for 150,000 miles; or
- A tank car requires general repairs and the repairs consume (or are expected to consume) at least 36 hours.

Although the FRA recommended tank car owners should modify tank cars with ACF-200 stub sill underframes, ACF maintenance bulletin TC-200 stated that the procedure may be used solely at the discretion of the car owner.

1.3.2 Association of American Railroads Maintenance Advisory

In response to an increasing number of stub sill-related defects found on tank cars during transportation, on October 1, 2010, the AAR published maintenance advisory (MA)-0123, advising tank car owners, repair shops, and railroads to intensify inspections of these structures during maintenance or other inspection events (AAR 2010). The advisory asked railroad operating and mechanical personnel to visually inspect the critical locations that could be seen during routine inspections or maintenance events. These critical locations (CL) are indicated in figure 5. The buckled and cracked shell of the incident tank car ADMX 28988 corresponded to the critical location highlighted by the dashed red circle.

¹¹ A *head brace* is a structure attached between the stub sill and tank head that manages stub sill loads into the tank body by reducing stress at critical underframe component weld locations.

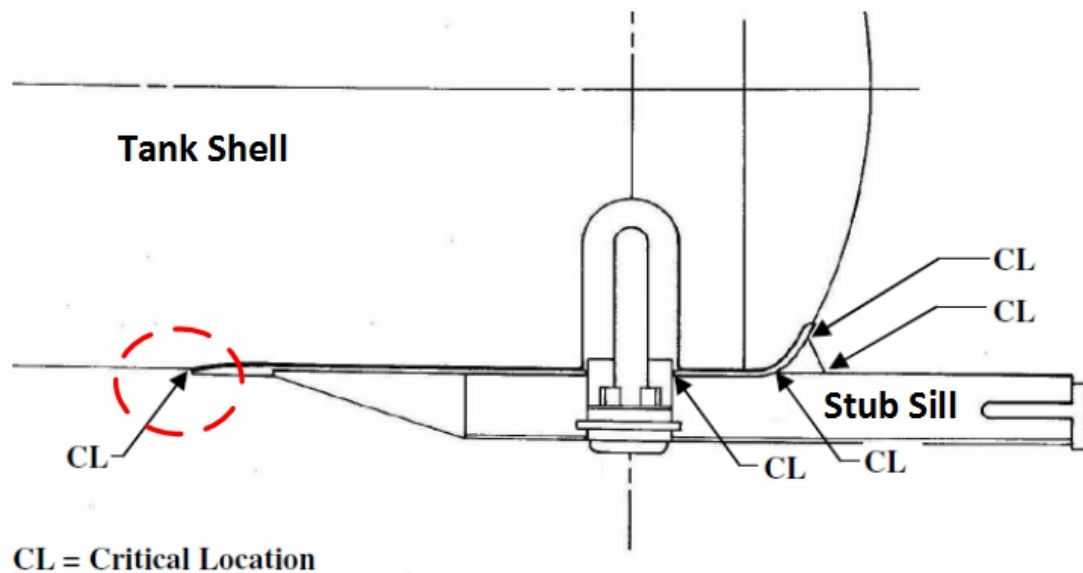

Figure 5. Diagram of a tank car stub sill underframe highlighting damage-prone critical locations where weld cracks are likely to occur.

The advisory stated that tank car owners must be notified if the tank has been damaged to a certain extent, including the bottom tank shell or stub sill reinforcing plate buckled 1/2 inch in depth or more. The advisory stated that when defect information is transmitted to tank car owners, the tank car owners should require the appropriate maintenance to ensure their equipment can safely operate.

Since the 2012 HM-201 inspection when ADM found and repaired four 3-inch cracks in the A-end and B-end bolster pad parent metal of ADMX 28988, ADM was not notified of any subsequent tank damage or shell buckling.

1.3.3 ACF Maintenance Bulletin TC-200, Revision B

On May 16, 2016, ARL published ACF Maintenance Bulletin TC-200 Revision B for ACF-200 stub sill underframe inspection, repair, and enhancement. The bulletin stated that it was especially applicable to nonpressure tank cars exposed to harsh service environments in which the cars may experience cracks in (1) the cradle pad parent metal, and (2) the weld attachments to the tank head (ARL 2016).

In addition to weld configuration and repair guidance, the bulletin described a retrofit procedure for the application of a head brace, or angle brace, known as the P470 enhancement. The bulletin noted that the procedure may only be used on ACF-200 underframes and solely at the discretion of the tank car owner. Further, the bulletin stated that prior to making any repairs or enhancements, it is critical that a thorough inspection is performed, and that each car should be individually evaluated using good judgement, based on the service environment and existing conditions. The bulletin added that if no defects are present, then no further repairs or enhancements are required.

ADM did not install the P470 enhancement on its fleet of tank cars.

1.4 Postincident Tank Car Examination

1.4.1 Shell Cracks

National Transportation Safety Board (NTSB) investigators found two tank shell cracks adjacent to the B-end cradle pad about 45° angles from the end of the inboard cradle pad fillet weld terminations. For the purposes of this report, the cracks were labeled “left” and “right” as shown in figure 6. At the exterior surface of the tank, the left crack was 3.15-inches long and the right crack was 2.40 inches long.

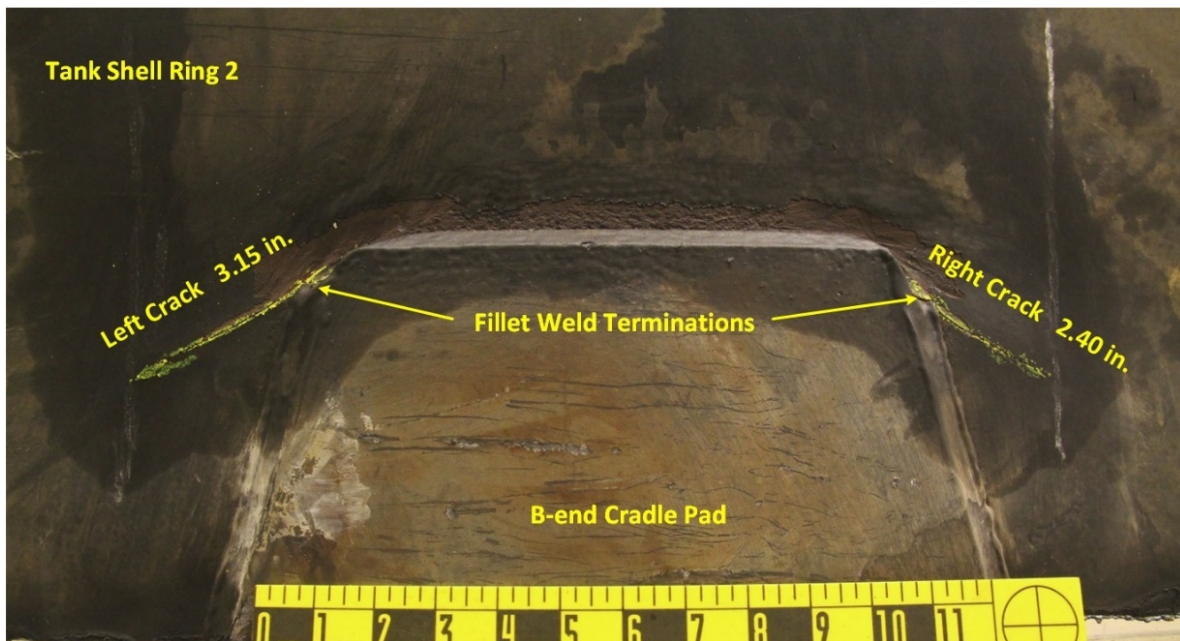

Figure 6. B-end tank car section, including the inboard end of the stub sill cradle pad and two shell cracks. The cracks initiated at the terminations of the longitudinal fillet welds.

Each crack exhibited two primary initiation sites, located at the inboard terminations of the cradle pad fillet welds. The cracks propagated away from the toes of the welds on each side of the cradle pad. Ratchet marks present on both fracture surfaces were consistent with multiple fatigue cracks that coalesced during propagation.¹²

The crack propagation features on both the left and right sides were consistent with a fatigue crack propagating from the outer tank surface, which, after having grown through most of the tank shell cross section, underwent reverse bending, whereby multiple smaller fatigue cracks

¹² *Ratchet marks* are the lines or the markings on a fatigue fracture surface that result from the intersection and connection of separate fatigue cracks propagating from multiple origins. Ratchet marks are parallel to the overall direction of crack propagation and can be visible to either the unaided eye or at low magnification.

initiated on the inner surface and grew outward. The fatigue cracks merged to become shell breaching through-cracks from which the contents of the tank car escaped.

As directed by applicable weld placement guidance in ACF maintenance bulletin TC-200, there was no indication of weld material present outside of acceptable weld locations, such as the transverse surface of the inboard cradle pad. NTSB investigators cross sectioned and examined both welds using optical metallography and microindentation hardness and found no indications of any weld deficiencies. The examination found no evidence of nonmetallic inclusions, voids, or pores at the fatigue crack initiation sites. The incident tank car shell did not exhibit any evidence of poor welding that might have contributed to the formation of the cracks and the release of ethanol.

1.4.2 Shell Buckling

The B-end shell contained an inward buckle inboard of the cradle pad with a maximum depth of 0.75 inches. Figures 7 and 8 show several depth measurements relative to a tank car longitudinal tangent, based on a laser scan of a section from the B-end of the tank car. These figures show the section upside down, with the outer surface of the tank car on the top and the cradle pad on the right.

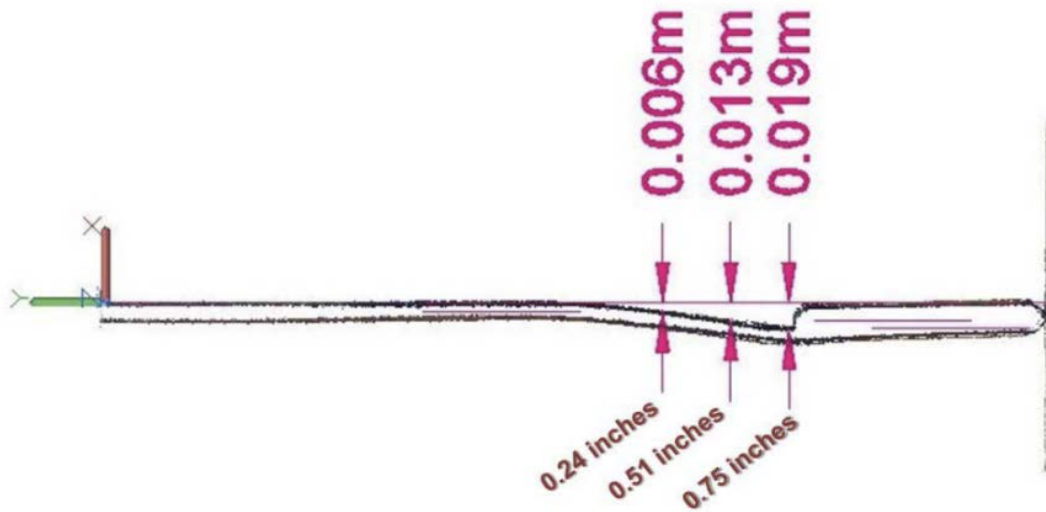

Figure 7. Plot of NTSB Materials Laboratory laser scan of the tank bottom showing shell buckling depth found at the inboard end of the cradle pad.

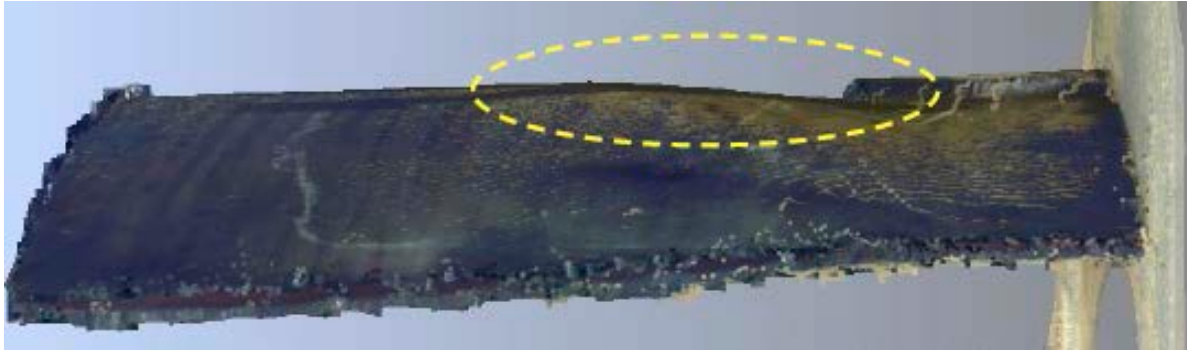

Figure 8. Visual rendering of laser scan data showing tank shell buckling at the inboard end of the cradle pad.

The apex of the buckle corresponded with the location of both fatigue cracks. This buckle depth exceeded the maximum allowable depth of 0.5 inches, as published in AAR maintenance advisory MA-0123 (AAR 2010) and AAR *Manual of Standards and Recommended Practices* (MSRP) Section C-III, Appendix R (AAR 2014). The AAR standard requires stub sill tank cars to be home shopped and the owner to be notified when tank shell deformation as large as that found in ADMX 29899 is present.¹³

1.4.3 Materials Testing

The tank shell thickness measured a minimum of 0.446 inches adjacent to the left crack and 0.445 inches adjacent to the right crack and was within specification. The tank shell steel microstructure was consistent with one typical for plain carbon steel. Its chemical composition was consistent with AAR TC128, Grade B.¹⁴ Testing of tensile specimens from the shell, oriented in the longitudinal direction of the shell, found the material exceeded the AAR TC128, Grade B minimum mechanical property requirements for yield strength, tensile strength, and elongation.¹⁵

1.5 Coupling Impact Loads

1.5.1 Finite Element Modeling and Analysis of Draft Gear Forces

NTSB investigators used finite element modeling to explore an idealization of a real coupling impact scenario that could have caused the buckle found in the incident tank car shell. The magnitude of the draft gear load was varied to study the effect on the underframe and tank shell.¹⁶ Investigators also constructed and studied an alternative model with a head brace, similar

¹³ *Home shop* is the repair facility designated by the tank car owner in accordance with AAR Rules 1, 114, and 115.

¹⁴ AAR TC128, Grade B is a standard for steels used in tank car manufacturing, as specified in AAR M-1002, (AAR 2014).

¹⁵ The tensile specimens were tested in accordance with ASTM A370 (ASTM 2018).

¹⁶ In this document, draft gear refers to an entire system of draft gear components including, but not limited to, the coupler, follower, draft gear, yoke, lugs, and striker plate.

in concept to the ACF P470 retrofit.¹⁷ The model was constructed using data the NTSB collected from the mechanical testing data, and thus the behavior of the tank material in the model was considered realistic. However, in the finite element model, the force was applied quasi-statically (in effect, very slowly), so any dynamic effects of the impact between cars were not included in the model; the effects of inertia and the variability of draft gear shock-absorbing performance were beyond the scope of the study.

The NTSB modeling showed that the draft gear force needed to create a buckle like that found on the incident tank car was about 3,715 kilopounds (kip). The depth contours of the tank bottom near the buckled region at the inboard end of the cradle pad give similar results to the damage found on the incident tank car. (See figure 9.)¹⁸

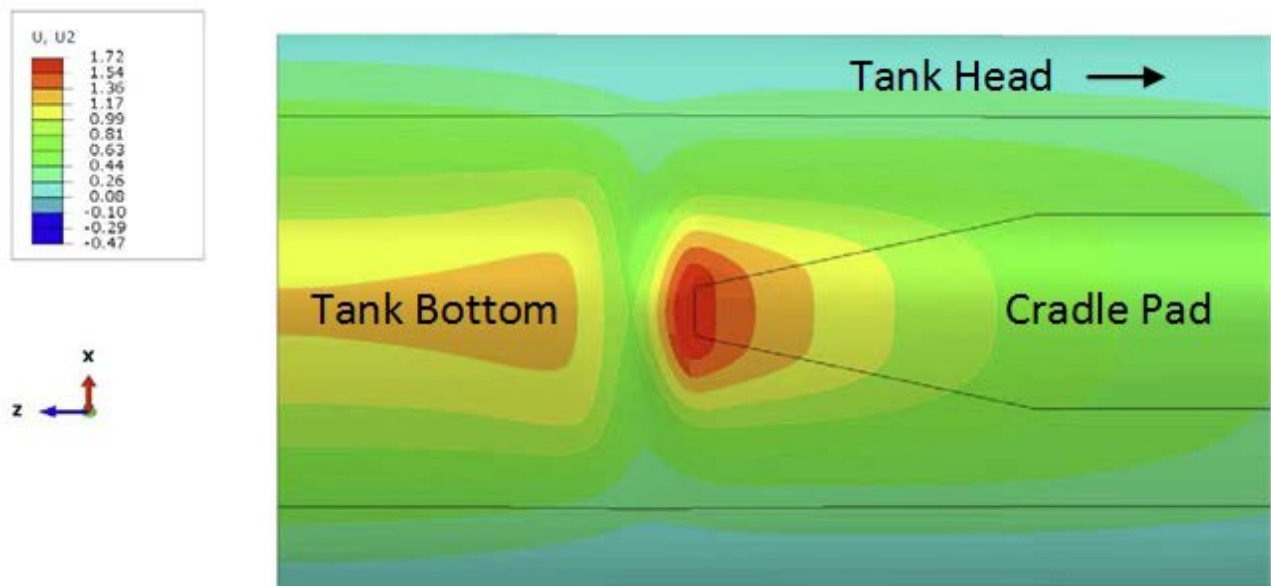

Figure 9. Finite element model result showing vertical displacement in inches following a quasi-static draft gear force of 3,715 kips.

1.5.2 Coupling Speed Research

The AAR Tank Car Committee reported at its January 2011 meeting that the major cause of stub sill failures are heavy single-ended impacts, and that loaded cars coupling in hump yards at 7 mph and empty cars coupling at 12 mph exceed the maximum design dynamic impact load requirements for tank cars (AAR 2015).

Additionally, in 2016 the FRA published the results of over-the-road testing on an instrumented DOT-111 tank car to better characterize the railway service environment. The FRA

¹⁷ The P470 retrofit is a modification to the ACF-200 underframe that is intended to address fatigue-related concerns by the application of an angle brace between the tank head and stub sill. This modification is described in Maintenance Bulletin TC-200.

¹⁸ The model had the force applied quasi-statically and was not a dynamic simulation that considered such effects as inertia. 1 kip = 1,000 pounds of force.

had documented a history of tank car stub sill fractures and the potential for them to develop into a variety of catastrophic failures and hazardous materials releases (FRA 2016). Over its 3,700-mile service test, the instrumented tank car experienced three longitudinal coupler force events that exceeded the AAR specification requiring tank cars to be capable of experiencing coupler forces of 1,000 kips without damage, all of which occurred in flat switching yards (AAR 2015). The study also found that of the 30 greatest longitudinal coupler force events, 19 occurred in flat switching yards, 10 occurred in hump yards, and only one occurred during normal operation. The highest force value produced during the testing was 1,790 kips, recorded when the instrumented tank car was being coupled into a standing set of cars from a speed of 9 mph.¹⁹

Continuing its research into the underlying causes of stub sill cracking and propagation, in 2018, the FRA Office of Research, Development and Technology conducted a series of more than 700 impact tests for different tank car configurations to provide better understanding of load scenarios during yard operations that could lead to structural damage (FRA 2019). The FRA researchers reported peak longitudinal coupler force data, as well as transferred momentum between cars for different draft gear types. Peak coupler force was measured and correlated to various impact speeds from 4 to 10 mph.²⁰ Statistical analysis revealed that the peak longitudinal coupler force is mostly influenced by coupling speed and draft gear type, not configurations of hammer and anvil cars or whether the hammer car was loaded or empty.²¹ However, the impulse during the impact, which is a measure of the momentum transferred between cars, is strongly dependent on configurations of loaded and empty cars and not on draft gear type.²² The FRA study showed that at impact speeds above 7 mph, the largest peak forces measured increased sharply with impact speed, rising from about 500 kips at 7.5 mph to about 1,500 kips at 10 mph.

1.5.3 Coupling Speed Regulations and Recommended Practices

Title 49 *CFR* 174.83, governing the switching of placarded railcars, states that any loaded railcar placarded for a Division 1.2 or Division 1.2 explosive, a Division 2.3 Hazard Zone A gas or a Division 6.1 PGI Hazard Zone A material, or a Class DOT 113 tank car displaying a Division 2.1 flammable gas placard, including a Class DOT 113 tank car containing only a residue of a Division 2.1 material, may not be cut off while in motion, or coupled into with more force than is necessary to complete the coupling, or struck by any car moving under its own momentum.

On November 5, 2015, the FRA's Railroad Safety Advisory Committee (RSAC) published Task Statement 15-04 to address hazardous materials issues, including 49 *CFR* 174.83 to consider a new requirement to identify high-impact forces during switching. RSAC also proposed a requirement for tank car owners to transmit information about high-energy coupling events into their maintenance and inspection programs. To date, this effort has not progressed to proposed rulemaking (DOT 2019).

¹⁹ A flat yard has a relatively flat vertical profile, whereas a hump yard has a raised portion of ground to control railcar movement by its gravity. Flat yards are generally more labor intensive because railcars are pushed by locomotives and hump yards are generally more automated and can classify a large volume of railcars more efficiently.

²⁰ The peak coupler force measured by the FRA was a dynamic force. Therefore, the NTSB finite element modeling study that applied quasi-static coupler force are not necessarily direct correlations.

²¹ The impacting car is referred to as the *hammer*, while the impact absorbing cars are referred to as the *anvil* cars.

²² *Impulse* is the integral of the force measured over the duration of the impact.

In addition to the federal regulation, AAR Circular OT-55-Q provides industry guidance for coupling tank cars containing hazardous materials, which states, “Maximum reasonable efforts will be made to achieve coupling of loaded placarded tank cars at speeds not to exceed 4 mph (AAR 2018).”

Furthermore, the AAR describes general requirements for switching placarded hazardous material railcars in its publication *United States Hazardous Materials Instructions for Rail*, which provides general guidelines to railroad employees on handling hazardous material shipments or incidents. The document states, “When rail cars are cut off in motion, the coupling speed must not exceed 4 mph (AAR 2015).”

For tank cars transporting more dangerous materials (such as toxic inhalation hazard materials, anhydrous ammonia, and flammable gases), Circular OT-55-Q further recommends that loaded tank cars which are cut off in motion for coupling must be handled in not more than two-car cuts; and cars cut off in motion to be coupled directly to a loaded tank car of these hazardous materials must also be handled in not more than two-car cuts. This provision manages draft gear forces by controlling the mass of hammer and anvil cars in motion, thereby limiting the stress imparted to tank car shells and underframes during coupling operations.

In contrast to the absence of United States prescriptive regulatory requirements to control tank car damage caused by coupler-load events, Transport Canada’s (TC) Transport of Dangerous Goods (TDG) regulations have required that a tank car containing dangerous goods may not be coupled to another railway vehicle at a relative coupling speed of greater than 9.6 km/h (6 mph) (TC 2019). The TDG regulations state that at temperatures above -13°F, single car cuts must not couple at speeds above 12 km/h (7.5 mph). These coupling speeds are based on tests in which the coupling force is less than the 1,000-kip AAR minimum longitudinal force specification that tank cars must sustain without damage (TSB 2004). TDG regulations also state that if a dangerous goods tank car is coupled with another railway vehicle and the three conditions in any one of the four rows in the following table apply, the underframe and coupling components of the tank car must be inspected to ensure their integrity before the tank car is moved more than 2 km from the place of coupling. These TDG regulations were implemented in 2002.

Table. Canadian Transport of Dangerous Goods coupling speed regulatory thresholds for structural integrity inspection.

Item	Combined Coupling Mass: Tank Car and Other Railway Vehicle, and their Contents	Ambient Temperature:	Relative Coupling Speed
1.	> 150,000 kg (330,700 lb)	≤ -25 °C (-13 °F)	> 9.6 kph (6.0 mph)
2.	> 150,000 kg (330,700 lb)	≤ -25 °C (-13 °F)	> 12 kph (7.5 mph)
3.	≤ 150,000 kg (330,700 lb)	≤ -25 °C (-13 °F)	> 12.9 kph (8.0 mph)
4.	≤ 150,000 kg (330,700 lb)	> -25 °C (-13 °F)	> 15.3 kph (9.5 mph)

TDG regulations further require the tank car owner be notified in writing within 10 days after such coupling and informed about any damage that compromises the integrity of the underframe assembly or draft gear discovered as a result of the inspection. The tank car owner must not use the tank car to transport dangerous goods until the tank undergoes visual and structural integrity inspections that include, among other things, the termination of stub sill reinforcement pad (cradle pad) closest to the midpoint of the tank car and associated welds

extending 30 centimeters (11.8 inches) toward the outboard end of the tank. The visual inspection must include the interior and exterior surfaces of the tank car except areas where an insulation system, safety system, or internal lining or coating precludes inspection (TC 2018). The structural integrity inspection must be performed by using one or more nondestructive evaluation methods set forth in Table T2 of the AAR Specifications for Tank Cars, and must include all locations of the tank car susceptible to damage, including the termination of longitudinal fillet welds with dimensions greater than 1/4 inch and within 48 inches of the bottom longitudinal centerline (AAR 2015).

2 Analysis

2.1 Coupling Impact Loads

The FRA and TC have characterized high-speed yard coupling impacts as extreme, since they can result in sill separation, tank failure, or severe tank distortion and initiate sudden crack nucleation or propagation. They have also expressed concern about lower magnitude events associated with crack growth by fatigue that are not severe enough to produce obvious structural defects (Rader and Gagnon 1999).

The finite element model indicated that a coupler force of 3,715 kips was required to cause the buckle observed in the incident tank car. In the FRA testing, the largest peak forces increased sharply with impact speed, rising from about 500 kips at 7.5 mph to about 1,500 kips at 10 mph (FRA 2019). A linear extrapolation of those data indicates that a force of 3,715 kips would require an impact speed of about 15.5 mph. The largest force measured in the field tests of an instrumented tank car was 1,790 kips, recorded when the instrumented tank car was being coupled into a standing set of cars from a speed of 9 mph (FRA 2016). Although the exact impact conditions cannot be determined, the results from the finite element model compared to the forces measured by the FRA testing show that the impact speed to cause the deformation observed in ADMX 29899 would have exceeded the AAR-recommended hazardous materials tank car coupling speed of 4 mph (AAR 2018). Therefore, the NTSB concludes that the tank shell buckle was likely the result of coupling at a speed higher than the AAR-recommended 4 mph.

Large coupling forces that occur in yard operations have the potential to exceed yield limits of steels and initiate stub sill damage. While FRA research suggests that coupling speed has the greatest influence on the peak longitudinal impact force, a tank car's weight has considerable effect on the impulse since larger mass corresponds to larger momentum and energy transfer (FRA 2019). The existing federal regulations do not provide an impact force or speed threshold, nor do they define what is meant by coupling with "more force than necessary." Moreover, industry guidance for "reasonable efforts" to limit coupling speed is not an enforceable metric. Therefore, the NTSB concludes that the risk of a hazardous materials release following high-force coupling events could be mitigated if federal regulations provided limits in the combination of coupling speed and impacting mass to tank car coupler and underframe components. Therefore, the NTSB recommends that the FRA and the Pipeline and Hazardous Materials Safety Administration (PHMSA) work together to develop maximum coupling speed thresholds and impact mass limits for hazardous materials railcars.

2.2 Structural Integrity of Stub Sill Underframes

NTSB investigators found that the addition of a head brace, such as the P470 enhancement type, would not have helped to prevent or relieve the formation of a shell buckle inboard of the cradle pad. Figure 10 compares the magnitude of shell buckling modeled on a tank car equipped with and without a head brace, showing nearly identical results. The left image shows the case without a head brace and the right image shows similar output when the tank is equipped with a head brace, such as the P470 enhancement.

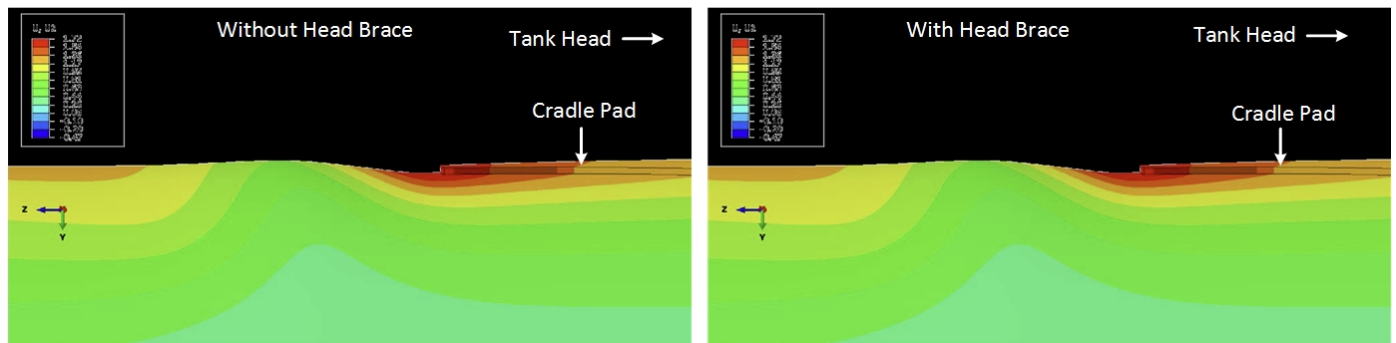

Figure 10. Finite element modeling output showing vertical displacement contours (units in inches) of the rotated tank bottom near the buckled region.

To further explain this modeling result, the NTSB simulated an additional case in which the head brace material was artificially made 10 times stiffer. The vertical displacement contours for this case resulted in a buckle of similar size to the original case. Therefore, the NTSB concludes that the decision to not install the P470 head brace enhancement on tank car ADMX 29899 did not affect the formation of a shell buckle in the region where the tank shell cracks occurred.

The buckle in the tank car likely led to elevated local residual stress, particularly at discontinuities or stress concentrations such as the inboard weld terminations. Supporting this finding is AAR Maintenance Advisory MA-0123, which identifies bottom tank buckling in excess of 1/2-inch depth as a critical location defect that poses the potential for “significant disruption” to rail operations (AAR 2010). Additionally, FRA Safety Advisory 2006-04, Notice no. 2, described the same failure mode as occurred in this incident, with its alert that included the propensity for cracks to develop in pad-to-tank welds of ACF-200 stub sill tank cars (FRA 2006). Moreover, this is not the first occurrence in which NTSB investigators found the loss of tank integrity at the inboard termination of an ACF-200 tank car cradle pad. In the investigation of the rupture of a DOT-105 tank car in New Martinsville, West Virginia, NTSB investigators conducted finite element modeling to examine local stresses in the tank near the inboard end of the ACF-200 cradle pad and found stress concentrations where a shell crack initiated in an identical location as occurred with ADMX 29899 (NTSB 2019). Therefore, the NTSB concludes that the shell buckle inboard of the cradle pad led to premature fatigue cracking in the tank shell.

The nonmandatory industry railcar coupling force guidance is not available for all hazardous materials. Some that are available include best practices for loaded tank cars containing flammable materials that may be assembled into high hazard flammable trains or tank cars that have been identified with damage-prone structures such as those equipped with ACF-200 stub sill underframes. Furthermore, the guidance for “reasonable efforts” to limit coupling speed is not an enforceable metric and lacks any requirement for structural integrity inspections following high-energy coupling events. Even AAR MA-0123, advising tank car owners, repair shops, and railroads to intensify inspections of stub sill structures during maintenance or other inspections does not specify events, such as energetic coupling, that would trigger the need for stub sill underframe inspections (AAR 2010).

To limit the risk of tank car failure, examinations following overspeed coupling must not be limited to cursory visual examinations by railway personnel because shell damage or cracks in welds that are concealed by a tank car jacket and insulation may not be easily detected. The use of

advanced nondestructive examination techniques may also be required to identify cracks in critical locations that are not readily visible from exterior shell surfaces. Therefore, the NTSB concludes that structural integrity inspections must be performed by qualified technicians at certified tank car facilities using specialized nondestructive examination techniques with a sufficient probability of detection to ensure that critical flaws are identified in tank materials. The NTSB recommends that based on the outcome of Recommendation 1, the FRA and PHMSA require that tank cars involved in high-energy coupling-force events undergo a structural integrity inspection by a qualified technician before returning to service.

2.3 Detecting Energetic Coupling Events

With the increased numbers of heavier 286,000-pound GRL railcars being placed in service, such as DOT-117 tank cars used in high hazard flammable trains, the magnitude of in-train and yard impact loads is likely to increase. In a joint white paper responding to concerns about increasing the authorized weight of tank cars from 263,000-pounds GRL to 286,000-pounds GRL, the FRA and TC noted many examples of severe impact events. Both the FRA and TC found that industry needed to develop a means to identify these types of events.

Typical methods for measuring coupling speeds in hump yards include process control computers that account for multiple factors, such as weight, the distance the car must roll to connect to the string of standing railcars, and factors affecting rolling resistance. These systems are designed to automatically control coupling speed using retarders situated at various points to apply desired speed adjustment braking to slow cars down to a proper speed for damage-free coupling on classification tracks. Railcar coupling speeds are typically measured with radar, wheel sensors, or rail contact devices. However, following a 2003 accident in which a tank car that was damaged after exiting a hump yard retarder at more than double the target speed because of a malfunctioning air-pressure controller, the Transportation Safety Board of Canada (TSB) found that despite regular inspection and maintenance, overspeed coupling can occur if a retarder or controller fails to apply the necessary braking force (TSB 2004a). There is currently no requirement for rail carriers in the United States to report such overspeed coupling events to railcar owners when detected.

There are existing methods to monitor overspeed and high-energy coupling force events, including on-board sensors that can provide access to real-time reporting of overspeed events and excessive coupler impact forces. Timely reports of such events can prompt the removal of damaged tank cars from hazardous materials service until necessary inspections and repairs have been completed. Monitoring solutions currently offered in the marketplace include but are not limited to telematic technology, which combines global positioning systems, wireless sensing sensors, and cellular communications networks. Telematic platforms equipped with acceleration sensors may alert asset owners when high-force impacts occur, whether container closures have been opened, or a tank has been emptied. Moreover, historical railcar operating environment data from these systems could be useful for establishing appropriate inspection and service intervals.

The NTSB concludes that without a means to detect and report excessive coupling speed events, damaged tank cars such as ADMX 29899 may continue in service and pose an unnecessary risk of hazardous materials releases. Therefore, the NTSB recommends that the FRA and PHMSA develop methods to identify tank cars that have sustained overspeed and high-energy coupling

force events. In addition, the NTSB recommends that after the successful development of methods to identify tank cars that have sustained overspeed and high-energy coupling force events, the FRA and PHMSA require that rail carriers have monitoring processes in place to promptly remove damaged tank cars from hazardous materials service.

3 Conclusions

3.1 Findings

1. The tank shell buckle was likely the result of coupling at a speed above the Association of American Railroads-recommended 4 mph.
2. The risk of a hazardous materials release following high-force coupling events could be mitigated if federal regulations provided limits in the combination of coupling speed and impacting mass to tank car coupler and underframe components.
3. The decision to not install the P470 head brace enhancement on tank car ADMX 29899 did not affect the formation of a shell buckle in the region where the tank shell cracks occurred.
4. The shell buckle inboard of the cradle pad led to premature fatigue cracking in the tank shell.
5. Structural integrity inspections must be performed by qualified technicians at certified tank car facilities using specialized nondestructive examination techniques with a sufficient probability of detection to ensure that critical flaws are identified in tank materials.
6. Without a means to detect and report excessive coupling speed events, damaged tank cars such as ADMX 29899 may continue in service and pose an unnecessary risk of hazardous materials releases.

3.2 Probable Cause

The National Transportation Safety Board determines that the probable cause of the November 2, 2016, release of denatured ethanol from Archer Daniels Midland Company tank car ADMX 29899 was undetected cracks that resulted from overspeed high-energy coupling events, which caused tank shell deformation that led to the initiation of two fatigue cracks at the terminations of the cradle pad fillet welds.

4 Recommendations

As a result of the investigation, the National Transportation Safety Board makes the following new safety recommendations:

To the Federal Railroad Administration and the Pipeline and Hazardous Materials Safety Administration:

Work together to develop maximum coupling speed thresholds and impact mass limits for hazardous materials railcars. (R-20-1)

Require that tank cars involved in high-energy coupling-force events undergo a structural integrity inspection by a qualified technician before returning to service. (R-20-2)

Develop methods to identify tank cars that have sustained overspeed and high-energy coupling force events. (R-20-3)

After the successful development of methods to identify tank cars that have sustained overspeed and high-energy coupling force events, require that rail carriers have monitoring processes in place to promptly remove damaged tank cars from hazardous materials service. (R-20-4)

BY THE NATIONAL TRANSPORTATION SAFETY BOARD

ROBERT L. SUMWALT, III
Chairman

JENNIFER HOMENDY
Member

BRUCE LANDSBERG
Vice Chairman

MICHAEL GRAHAM
Member

THOMAS B. CHAPMAN
Member

Date: February 14, 2020

Appendix

The National Transportation Safety Board (NTSB) was notified on November 2, 2016, that 68 gallons of UN1987 denatured alcohol had released from CSX Transportation (CSX) tank car ADMX 29899 in the CSX rail yard in Fredericksburg, Virginia. At 3:00 p.m. on the day of the incident, an NTSB investigator arrived at the rail yard and documented damage to the breached tank car with a Federal Railroad Administration hazardous materials inspector and a CSX hazardous materials officer. On February 13, 2017, investigators conducted a follow-up metallurgical examination of the tank fracture origin and crack surfaces of a tank shell coupon from the breached tank car at the NTSB Materials Laboratory in Washington, DC. Investigators also submitted tank shell specimens to a contract laboratory for mechanical and chemical testing. Additionally, NTSB investigators performed finite element modeling, using Abaqus version R2016x, to study possible scenarios that could have caused the incident tank car damage.

The parties to the investigation include the Federal Railroad Administration, CSX Transportation, and Archer Daniels Midland Company.

References

- AAR (Association of American Railroads). 2010. *Inspection of Tank Car Stub Sills*. MA-0123 (CPC-1218). Washington, DC: AAR.
- . 2014. *Manual of Standards and Recommended Practices, Specifications for Tank Cars*, Section C, Part III (M-1002). Washington, DC: AAR.
- . 2015. *United States Hazardous Materials Instructions for Rail*. Washington, DC: AAR.
- . October 2015. “Review Static and Dynamic Load Requirements for Tank Cars.” Summary of task force activities, the Association of American Railroads Tank Car Committee, Colorado Springs, Colorado.
- . 2018. *Recommended Railroad Operating Practices for Transportation of Hazardous Materials*. Circular No. OT 55-Q. (CPC-1337). Washington, DC: AAR.
- ARL (American Railcar Leasing). 2006. *ACF-200 Stub Sill Underframe, Inspection, Repair, and Enhancement*. ACF Maintenance Bulletin TC-200, Revision A. St. Charles, Missouri: ARL.
- . 2016. *ACF-200 Stub Sill Underframe, Inspection, Repair, and Enhancement*. ACF Maintenance Bulletin TC-200, Revision B. St. Charles, Missouri: ARL.
- ASTM (American Society for Testing and Materials). 2018. *Standard Test Methods and Definitions for Mechanical Testing of Steel Products*. A370. West Conshohocken, Pennsylvania: ASTM International.
- DOT (US Department of Transportation). 2019. *August 2019 Significant Rulemaking Report*. Washington, DC: US Department of Transportation.
- FRA (Federal Railroad Administration). 2006. *Safety Advisory 2006-04* (Notice No. 2). Washington, DC: US Department of Transportation, FRA.
- . 2016. *Force Environment Evaluation of Stub Sills on Tank Cars Using Autonomous Over-the-Road Testing of the Instrumented Tank Car*. DOT/FRA/ORD-16/39. Washington, DC: US Department of Transportation, FRA.
- . 2019. *Yard Impact Tests of a Tank Car*. Research Results Report RR-19-17. Washington, DC: US Department of Transportation, FRA.
- FR (*Federal Register*). 1995. Vol. 60, no. 183 (September 21).
- NTSB (National Transportation Safety Board). 2019. *Rupture of a DOT-105 Rail Tank Car and Subsequent Chlorine Release at Axiall Corporation, New Martinsville, West Virginia, August 27, 2016*. HZM-19/01. Washington, DC: NTSB.

Rader, J.H. and Gagnon, J.P. 1999. *Maximizing Safety and Weight: A White Paper on 263K+ Tank Cars*. Washington, DC: US Department of Transportation, FRA and Transport Canada.

TC (Transport Canada). 2018. *Containers for Transport of Dangerous Goods by Rail*. TP14877E. Ottawa, Ontario, Canada: TC.

———. 2019. *Transportation of Dangerous Goods Regulations*. “Coupling of Railway Vehicles”, Section 10.7. SOR/2019-101. Ottawa, Ontario, Canada: TC.

TSB (Transportation Safety Board of Canada). 2004. *Canadian National Tank Car PROX 77811, Mile 25.0, York Subdivision, Toronto, Ontario, 22 January 2003*. Railway Investigation Report R03T0047. Ottawa, Ontario, Canada: TSB.

———. 2004a. *Canadian Pacific Railway Tank Car HOKX 111044, Mile 197.0, Belleville Subdivision, Toronto, Ontario, 21 January 2003*. Railway Investigation Report R03T0026. Ottawa, Ontario, Canada: TSB.